

INSTALLATION GUIDE
Agilent Technologies
MPS Mainframe
Model 66000A

SERIAL NUMBERS

For mainframe with serial numbers:
Agilent Model 66000A: 3138A-00101 and above

* For instruments with higher Serial Numbers, a change page may be included.



Agilent Technologies

CERTIFICATION

Agilent Technologies certifies that this product met its published specifications at time of shipment from the factory. Agilent Technologies further certifies that its calibration measurements are traceable to the United States National Bureau of Standards, to the extent allowed by the Bureau's calibration facility, and to the calibration facilities of other International Standards Organization members.

WARRANTY

This Agilent Technologies hardware product is warranted against defects in material and workmanship for a period of three years from date of delivery. Agilent Technologies software and firmware products, which are designated by Agilent Technologies for use with a hardware product and when properly installed on that hardware product, are warranted not to fail to execute their programming instructions due to defects in material and workmanship for a period of 90 days from date of delivery. During the warranty period Agilent Technologies will, at its option, either repair or replace products which prove to be defective. Agilent Technologies does not warrant that the operation of the software, firmware, or hardware shall be uninterrupted or error free.

For warranty service, with the exception of warranty options, this product must be returned to a service facility designated by Agilent Technologies. Customer shall prepay shipping charges by (and shall pay all duty and taxes) for products returned to Agilent Technologies for warranty service. Except for products returned to Customer from another country, Agilent Technologies shall pay for return of products to Customer.

Warranty services outside the country of initial purchase are included in Agilent Technologies product price, only if Customer pays Agilent Technologies international prices (defined as destination local currency price, or U.S. or Geneva Export price).

If Agilent Technologies is unable, within a reasonable time to repair or replace any product to condition as warranted, the Customer shall be entitled to a refund of the purchase price upon return of the product to Agilent Technologies.

LIMITATION OF WARRANTY

The foregoing warranty shall not apply to defects resulting from improper or inadequate maintenance by the Customer, Customer-supplied software or interfacing, unauthorized modification or misuse, operation outside of the environmental specifications for the product, or improper site preparation and maintenance. NO OTHER WARRANTY IS EXPRESSED OR IMPLIED. AGILENT TECHNOLOGIES SPECIFICALLY DISCLAIMS THE IMPLIED WARRANTIES OF MERCHANTABILITY AND FITNESS FOR A PARTICULAR PURPOSE.

EXCLUSIVE REMEDIES

THE REMEDIES PROVIDED HEREIN ARE THE CUSTOMER'S SOLE AND EXCLUSIVE REMEDIES. AGILENT TECHNOLOGIES SHALL NOT BE LIABLE FOR ANY DIRECT, INDIRECT, SPECIAL, INCIDENTAL, OR CONSEQUENTIAL DAMAGES, WHETHER BASED ON CONTRACT, TORT, OR ANY OTHER LEGAL THEORY.

ASSISTANCE

The above statements apply only to the standard product warranty. Warranty options, extended support contracts, product maintenance agreements and customer assistance agreements are also available. Contact your nearest Agilent Technologies Sales and Service office for further information on Agilent Technologies' full line of Support Programs.

SAFETY SUMMARY

The following general safety precautions must be observed during all phases of operation, service, and repair of this mainframe. Failure to comply with these precautions or with specific warnings elsewhere in this guide violates safety standards of design, manufacture, and intended use of the mainframe. Agilent Technologies assumes no liability for the customer's failure to comply with these requirements.

BEFORE APPLYING POWER.

Verify that the product is set to match the available line voltage and the correct fuse is installed.

GROUND THE MAINFRAME.

This product is a Safety Class I instrument (provided with a protective earth terminal). To minimize shock hazard, the mainframe must be connected to an electrical ground. The mainframe must be connected to the ac power supply mains through a three-conductor power cable, with the third wire firmly connected to an electrical ground (safety ground) at the power outlet. Any interruption of the protective (grounding) conductor or disconnection of the protective earth terminal will cause a potential shock hazard that could result in personal injury.

DO NOT OPERATE IN AN EXPLOSIVE ATMOSPHERE.

Do not operate the instrument in the presence of flammable gases or fumes.

KEEP AWAY FROM LIVE CIRCUITS.

Operating personnel must not remove instrument covers. Component replacement and internal adjustments must be made by qualified service personnel. Do not replace components with power cable connected. Under certain conditions, dangerous voltages may exist even with the power cable removed. To avoid injuries, always disconnect power, discharge circuits and remove external voltage sources before touching components.

DO NOT SERVICE OR ADJUST ALONE.

Do not attempt internal service or adjustment unless another person, capable of rendering first aid and resuscitation, is present.

DO NOT EXCEED INPUT RATINGS.

This mainframe is equipped with a power line filter to reduce electromagnetic interference and must be connected to a properly grounded receptacle to minimize electric shock hazard. Operation at line voltages or frequencies in excess of those stated on the line rating label may cause leakage currents in excess of 5.0 mA peak.

SAFETY SYMBOLS.



Instruction manual symbol: the product will be marked with this symbol when it is necessary for the user to refer to the instruction manual (refer to Table of Contents).



Indicates hazardous voltages.

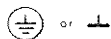

Indicates earth (ground) terminal.

WARNING

The WARNING sign denotes a hazard. It calls attention to a procedure, practice, or the like, which, if not correctly performed or adhered to, could result in personal injury. Do not proceed beyond a WARNING sign until the indicated conditions are fully understood and met.

CAUTION

The CAUTION sign denotes a hazard. It calls attention to an operating procedure, or the like, which, if not correctly performed or adhered to, could result in damage to or destruction of part or all of the product. Do not proceed beyond a CAUTION sign until the indicated conditions are fully understood and met.

DO NOT SUBSTITUTE PARTS OR MODIFY INSTRUMENT.

Because of the danger of introducing additional hazards, do not install substitute parts or perform any unauthorized modification to the instrument. Return the instrument to an Agilent Technologies Sales and Service Office for service and repair to ensure that safety features are maintained.

Mainframes that appear damaged or defective should be made inoperative and secured against unintended operation until they can be repaired by qualified service personnel.

















SAFETY SUMMARY (continued)

GENERAL: Any LEDs used in this product are Class 1 LEDs as per IEC 825-1.

ENVIRONMENTAL CONDITIONS:

This instrument is intended for indoor use in an installation category II, pollution degree 2 environment. It is designed to operate at a maximum relative humidity of 95% and at altitudes of up to 2000 meters. Refer to the specifications tables for the ac mains voltage requirements and ambient operating temperature range.

SAFETY SYMBOL DEFINITIONS

Symbol	Description	Symbol	Description
	Direct current		Terminal for Line conductor on permanently installed equipment
	Alternating current		Caution, risk of electric shock
	Both direct and alternating current		Caution, hot surface
	Three-phase alternating current		Caution (refer to accompanying documents)
	Earth (ground) terminal		In position of a bi-stable push control
	Protective earth (ground) terminal		Out position of a bi-stable push control
	Frame or chassis terminal		On (supply)
	Terminal for Neutral conductor on permanently installed equipment		Off (supply)
	Terminal is at earth potential (Used for measurement and control circuits designed to be operated with one terminal at earth potential.)		Standby (supply) - Units with this symbol are not completely disconnected from ac mains when this switch is off. To completely disconnect the unit from ac mains, either disconnect the power cord or have a qualified electrician install an external switch.

Herstellerbescheinigung

Diese Information steht im Zusammenhang mit den Anforderungen der Maschinenlärminformationsverordnung vom 18 Januar 1991.

* Schalldruckpegel Lp <70 dB(A) * Am Arbeitsplatz * Normaler Betrieb
* Nach EN 27779 (Typprüfung).

Manufacturer's Declaration

This statement is provided to comply with the requirements of the German Sound Emission Directive, from 18 January 1991.

* Sound Pressure Lp <70 dB(A) * At Operator Position * Normal Operation
* According to EN 27779 (Type Test).

DECLARATION OF CONFORMITY

according to ISO/IEC Guide 22 and EN 45014

Manufacturer's Name: Agilent Technologies, Inc.

Manufacturer's Address: 140 Green Pond Road
Rockaway, New Jersey 07866
U.S.A.

declares that the Product

Product Name: Modular Power System mainframe and modules

Model Number: Agilent 66000A mainframe and modules
Agilent 66101A, 66102A, 66103A, 66104A, 66105A, 66106A

conforms to the following Product Specifications:

Safety: IEC 348:1978 / HD 401S1: 1981¹

EMC: CISPR 11:1990 / EN 55011:1991 - Group 1 Class A
IEC 801-2:1991 / EN 50082-1:1992 - 4 kV CD, 8 kV AD
IEC 801-3:1984 / EN 50082-1:1992 - 3 V / m
IEC 801-4:1988 / EN 50082-1:1992 - 0.5 kV Signal Lines
1 kV Power Lines

Supplementary Information:

The product herewith complies with the requirements of the Low Voltage Directive 73/23/EEC and the EMC Directive 89/336/EEC and carries the CE-marking accordingly.

Note 1: The product family was introduced prior to 12/93.

New Jersey
Location

January 1997
Date



Bruce Krueger / Quality Manager

European Contact: Your local Agilent Technologies Sales and Service Office or Agilent Technologies GmbH, Department TRE, Herrenberger Strasse 130, D-71034 Boeblingen (FAX: +49-7031-14-3143)

Printing History

The current edition of this guide is indicated below. Reprints of this guide containing minor corrections and updates may have the same printing date. New editions are identified by a new printing date and, in some cases, by a new part number. A new edition incorporates all new or corrected material since the previous edition. Changes to the guide occurring between editions are covered by change sheets shipped with the guide. Also, if the serial number prefix of your mainframe is higher than those listed on the title page of this guide, then it may or may not include a change sheet. That is because even though the higher serial prefix indicates a design change, that change may not affect the content of the guide.

Edition 1 ... October, 1991 (Agilent Model 66000A)
Update April 2000

© Copyright 1991 Agilent Technologies, Inc.

This document contains proprietary information protected by copyright. All rights are reserved. No part of this document may be photocopied, reproduced, or translated into another language without the prior consent of Agilent Technologies. The information contained in this document is subject to change without notice.

Table Of Contents

1. General Information	
Introduction	9
Safety Considerations	9
Instrument Identification	9
Options and Parts	10
Description	10
Specifications and Supplemental Characteristics	11
2. Installation	
Installation	13
Items Supplied	13
Input Power	13
Line Voltage Conversion	13
Fuses	14
Power Cord Installation	14
Location and Cooling	15
Bench Operation	15
Rack Mounting	15
Temperature Performance	15
Rear Panel Switches	16
Address Switches	16
Frame Mode Switch	16
Module Installation	18
Module Removal	18
Mainframe Turn-On Checkout	19
3. Connections	
Rear Panel	21
Module Connections	21
Controller Connections	22
Multiple MPS Mainframes	22
MPS Mainframe/Power Supply Connections	22
Keyboard Connection	22
Digital Connections	22
Trigger Connections	24
Index	27

Figures

2-1.	Power Cord Plug Configurations	14
2-2.	Power Cord Installation	15
2-3.	Rear Panel Switches	16
2-4.	Switch Settings	17
2-5.	Module Pull Tab	18
3-1.	Rear Panel Connections	21
3-2.	Controller Connections	23
3-3.	Digital Connector	24
3-4.	Examples of the Remote Inhibit Function	25

Tables

1-1.	Specifications and Supplemental Characteristics	11
------	---	----

General Information

Introduction

This guide describes how to install the Agilent 66000A Modular Power System (MPS) Mainframe. It includes the following information:

- specifications and operating characteristics
- connecting the power cord to the mainframe
- setting the address and frame switches
- installing modules in the mainframe
- mainframe rear panel connections

Mainframe turn-on and checkout procedures are included with the module manual since an installed module is required to properly check out mainframe operation. Refer to the module *User's Guide* for more information.

Related Documents	Agilent Part No.
Programming Guide for Agilent Series 66lxxA MPS Power Modules	5959-3362
Installation Guide for DC Module Connectors	5959-3366
User's Guide for Agilent 66lxxA Power Modules	5959-3360
Service Guide for Agilent Series 66lxxA MPS Power Modules	5959-3364
Service Guide for Agilent 66000A Modular Power System Mainframe	66000-90003
Quick Reference Card for optional Agilent 66001A MPS Keyboard	66001-90001
Agilent 66000A Modular Power System Product Note	5091-2497E

Safety Considerations

This mainframe is a Safety Class 1 instrument, which means that it has a protective earth terminal. That terminal must be connected to earth ground through a power source equipped with a 3-wire ground receptacle.

Refer to the safety summary page at the beginning of this manual for general safety information. Before installation or operation, check the mainframe and review this manual for safety markings and instructions. Safety information for specific procedures is located at the appropriate places in this manual.

Instrument Identification

The mainframe is identified by a two-part serial number, such as 3140A-01234, on the back of the unit. The first part, or prefix, is a number-letter combination that describes:

3140 The year and week of manufacture or last significant design change. Add 1960 to the first two digits to determine the year. For example, 31=1991, 32=1992, etc. The last two digits specify the week of the year (40 = the 40th week).

A The letter indicates the country of manufacture, where A = USA.

Options and Parts

The following options are available with the mainframe:

Option	Description
908	Rack Mounting Kit
909	Rack Mounting Kit with handles
910	Extra Manual Set
Power Cords	
831	12 AWG unterminated power cord
833	1.5 mm ² unterminated power cord
834	10 AWG unterminated power cord
841	20 A/250 V NEMA 6-20P plug with 12 AWG power cord
843	20 A/250 V JIS C8303 plug with 12 AWG power cord
845	16 A/220 V IEC 309 plug with 1.5 mm ² power cord
846	30 A/120 V L5-30P locking plug with 10 AWG power cord
847	16 A/220 V CEE 7/7 plug with 1.5 mm ² power cord
848	15 A/240 V BS 546 plug with 1.5 mm ² power cord

The following mainframe items can be ordered separately:

Part Description	Part Number
Safety cover, ac input	5040-1676
Strain relief	1400-1195
Screw, strain relief	0515-2086
Power barrier block (Figure 2-2)	0360-2421
Screw, power barrier block	2470-0001
Serial link cable (1 meter)	5080-2148
Digital connector plug (Figure 3-3)	1252-1488
Filler panel (8 supplied)	66000-40006
Mainframe Installation Guide	66000-90001

Description

The Agilent 66000 Modular Power System (MPS) is an integrated, fully programmable power system that saves rack space and GPIB addresses, and is easy to install and use. Each Agilent 66000A MPS Mainframe can accommodate up to eight single-slot modules. With an auxiliary mainframe connected through a serial link cable, up to sixteen single-slot modules can be controlled from a single GPIB address. For applications requiring a broader range of power ratings, the Agilent 66000 system can be serial-linked to the Agilent 667xA, 665xA, 664xA, and 603xA series power supplies.

Modules are removed and installed through the front of the mainframe. Each module has a connector that attaches to the back of the mainframe. With the module connector wired and attached to the mainframe, the module slides in and out of the mainframe without disturbing the application connections.

The optional Agilent 66001A MPS Keyboard is available for controlling the Agilent 66000 Modular Power System without having to connect it to a computer.

Specifications and Supplemental Characteristics

Table 1-1 lists the specifications and supplemental characteristics of the MPS mainframe. Module specifications are included in the appropriate module *User's Guide*. Specifications are warranted in the temperature range of 0 to 55 degrees C. Supplemental characteristics are not warranted, but are descriptions of minimum, maximum, or average performance that has been determined by design or type testing.

Table 1-1. Specifications and Supplemental Characteristics

PERFORMANCE SPECIFICATIONS	
AC Input Ratings	
Standard:	87- 132 Vac 174- 250 Vac
Frequency tolerance:	47 - 63 Hz
SUPPLEMENTAL CHARACTERISTICS	
Maximum AC Line Current Ratings (with 8 power supply modules operating at maximum output)	
100 Vac:	29 A rms
120 Vac:	25 A rms
200 Vac:	16 A rms
220/230 Vac:	16 A rms
240 Vac:	15 A rms
Maximum power input:	3200 VA; 1800 W maximum; 1600 W typical
GPIB Interface Capabilities	
Languages:	Standard Commands for Programmable Instruments (see module <i>Programming Guide</i>)
IEEE 488.2 Capabilities:	SH1, AH1, T6, L4, SR1, RL1, PPO, DC1, DT1, EI, and CO
Serial Link Capabilities (Multiple mainframes sharing one GPIB address)	
Number of mainframes:	2
Number of modules:	16
Serial-linked power supplies:	total number of modules and serial-linked power supplies (Agilent 667xA/665xA/664xA/603xA) cannot exceed 16
Chain length:	30 m (100 ft) maximum
TrigIn/TrigOut Characteristics	
Maximum Ratings:	± 16.5 V between center conductor and chassis
Trig Out (HC TTL output):	V_{OL} @ 4 ma = 1.34 V maximum V_{OL} @ 2 ma = 0.8 V maximum V_{OH} 4 ma = 2.66 V minimum V_{OH} 2 ma = 3.18 V minimum
Trig In (10k pull-up):	I_{IL} @ 4 V = 700 μ A I_{IH} @ 5.25 V = 200 μ A V_{IL} = 0.8 V maximum V_{IH} = 2.0 V minimum

Table 1-1. Specifications and Supplemental Characteristics (continued)

INH/FLT Characteristics	
Maximum Ratings:	± 16.5 V between pins 3 and 4 $+ 16.5$ V between pins 1 and 2 $- 5.3$ V between pins 1 and 2
INH (10k pull-up):	I_{IL} @ 4 V = 700 μ A I_{IH} @ 5.25 V = 200 μ A V_{IL} = 0.8 V maximum V_{IH} = 2.0 V minimum
DFI (open collector):	V_{CE} = 0.4 V maximum @ IC = 2.2 mA I_{IH} @ 5.25 V = 200 μ A V_{IL} = 0.8 V maximum V_{IH} = 2.0 V minimum
Dimensions	
Width:	426 mm (16.75 in)
Height:	178 mm (7 in), add 13 mm (0.5 in) for removable feet
Depth:	678 mm (26.7 in), including module connectors
Weight (does not include modules)	
Net:	15 kg/33 lbs.
Shipping:	19 kg/41 lbs.
Environmental & Safety Compliance	CSA 556B IEC 348 UL 1244 VDE 0411
RFI Suppression	VDE 0871.6.78 Level B

Installation

Installation

When you receive your mainframe, first look for any obvious damage that could have occurred during shipment. If there is damage, notify the carrier and the nearest Agilent Sales Office immediately. Warranty information is printed behind the cover page of this manual.

Save the shipping carton and packing materials in case the mainframe has to be returned to Agilent Technologies in the future. If you return the mainframe for service, attach a tag identifying the owner and model number. Also include a brief description of the problem.

Items Supplied

In addition to this manual, check that the following items are included with the mainframe:

Power Cord Your mainframe was shipped with a power cord for the type of outlet used at your location. Depending on the option that was ordered, some power cords are shipped without a plug. If the appropriate cord was not included, refer to the option list in Chapter 1 and contact your nearest Agilent Sales and Service Office to obtain the correct cord.

CAUTION

Your mainframe cannot use a standard power cord. The power cords listed in Chapter 1 have heavier gauge wire.

Filler Panels Eight filler panels are included with each mainframe. Filler panels are installed in empty module slots.

Serial Cable A 1-meter serial cable that connects to the J1 connector next to the GPIB connector. This is used to serially connect two mainframes or a mainframe with power supplies that have the serial-link capability on the same GPIB address.

Keyboard Reference Card A quick reference card for the optional Agilent 66001A MPS Keyboard is included with the mainframe.

Manual If applicable, change sheets may be included with this manual. If change sheets are included, make

Change Sheet the corrections to the manual.

Input Power

You can operate your mainframe either from a 87 - 132 Vac or a 174 - 250 Vac single phase ac power source. Refer to Chapter 1 for complete input power specifications and requirements.

Line Voltage Conversion

The mainframe contains no line voltage switches. Refer to the module *User's Guide* for information on changing the line voltage.

Fuses

The mainframe fuse is located inside the mainframe. Refer to the mainframe *Service Manual* for information about replacing the fuse.

Power Cord Installation

The power cord supplied with your mainframe may or may not include a power plug. Figure 2-1 shows the various power plugs. Ring terminals are attached to one end of the power cord to facilitate mainframe installation.

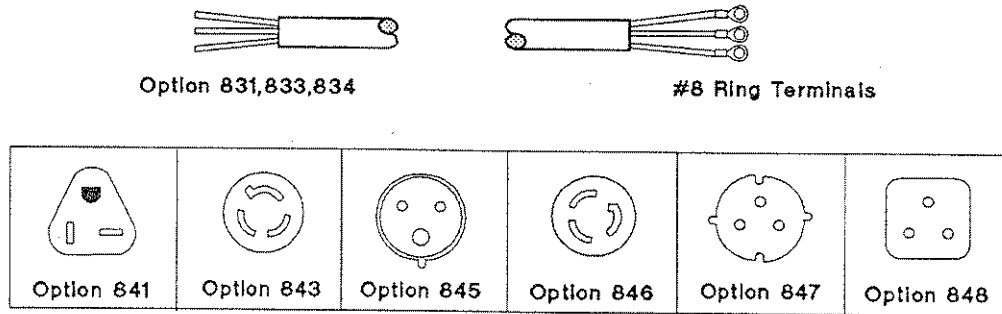

Figure 2-1. Power Cord Plug Configurations

WARNING

If your power cord will be directly wired into your location's power system, installation must be done by a qualified electrician and in accordance with local electrical codes.

To install the power cord, refer to Figure 2-2 and proceed as follows:

- Position the strain relief connector, safety cover, rubber boot, and connector nut on the power cord.
- Secure the ground wire to the earth ground stud.
- Connect the neutral wire to the "N" input terminal.
- Connect the line wire to the "L" input terminal.

Note

Route the power cord wires upward from the terminal block. This allows room to install the safety cover.

- Replace the safety cover and tighten the cover and strain relief screws.

CAUTION

Do not apply power to the mainframe until directed to do so in the Check-out procedure located in the module *User's Guide*.

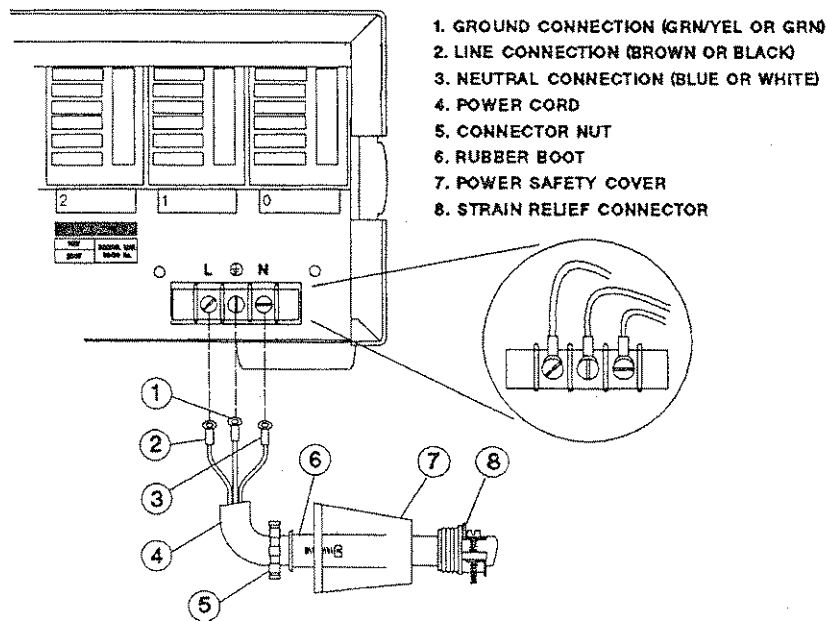

Figure 2-2. Power Cord Installation

Location and Cooling

Bench Operation

Chapter 1 gives the dimensions of your mainframe. The mainframe has plastic feet that are shaped to ensure self-alignment when stacked with other Agilent System II cabinets. The feet may be removed for rack mounting. Your mainframe must be installed in a location that allows sufficient space at the sides and rear of the mainframe for adequate air circulation. Do not block the vents at the sides and rear of the mainframe.

Rack Mounting

The mainframe can be mounted in a standard 19-inch rack panel or cabinet. Refer to Chapter 1 for mainframe dimensions. A fully loaded mainframe can weigh over 36 kg (80 lbs). Install the mainframe into the rack before installing the modules into the mainframe.

Rack mounting kits are available as option numbers 908 and 909 (with handles). Installation instructions are included with each rack mounting kit.

Note

Instrument support rails are also required for rack mounting. These are normally supplied with the cabinet and are **not** included with the rack mounting kits.

Temperature Performance

The mainframe can operate within the temperature range of 0° to 55° C. Fans in each module cool the modules by drawing in air through the sides of the mainframe and exhausting it out the back. Using Agilent rack mount or slide kits will not impede the flow of air.

Rear Panel Switches

The six-position rear panel switch is shown in the following figure.

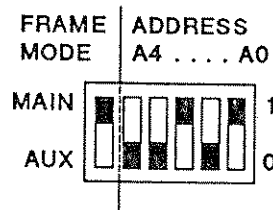

Figure 2-3. Rear Panel Switches

Address Switches

Address switches A0 through A4 set the primary GPIB address. The address is set in binary, A0 being the least significant bit and A4 being the most significant bit. Figure 2-3 shows the factory-set address of "5" (binary 00101). Any address from decimal 0 to decimal 30 is a valid GPIB address. Refer to the following diagram for switch settings.

Address	Switch Positions				
	A4	A3	A2	A1	A0
0	0	0	0	0	0
1	0	0	0	0	1
2	0	0	0	1	0
3	0	0	0	1	1
4	0	0	1	0	0
5	0	0	1	0	1
6	0	0	1	1	0
7	0	0	1	1	1
8	0	1	0	0	0
9	0	1	0	0	1

Address	Switch Positions				
	A4	A3	A2	A1	A0
10	0	1	0	1	0
11	0	1	0	1	1
12	0	1	1	0	0
13	0	1	1	0	1
14	0	1	1	1	0
15	0	1	1	1	1
16	1	0	0	0	0
17	1	0	0	0	1
18	1	0	0	1	0
19	1	0	0	1	1

Address	Switch Positions				
	A4	A3	A2	A1	A0
20	1	0	1	0	0
21	1	0	1	0	1
22	1	0	1	1	0
23	1	0	1	1	1
24	1	1	0	0	0
25	1	1	0	0	1
26	1	1	0	1	0
27	1	1	0	1	1
28	1	1	1	0	0
29	1	1	1	0	1
30	1	1	1	1	0

Frame Mode Switch

The frame mode switch determines the IEEE 488 secondary addresses (also referred to as subaddresses) of the modules that are installed in the mainframe. The frame mode switch must be set to **MAIN** when the mainframe is connected directly to the GPIB. With the frame mode switch set to **MAIN**, modules are assigned secondary addresses of 0 to 7, which corresponds to the slot locations indicated on the mainframe.

The frame mode switch must be set to **AUX** (auxiliary) when the mainframe is serially-linked to another mainframe that is directly connected to the GPIB. This also applies when the mainframe is serially linked to an Agilent 603xA/664xA/665xA/667xA power supply that is directly connected to the GPIB.

In mainframes that have the frame mode switch set to **AUX**, modules are assigned secondary addresses of 8 to 15. Secondary address 8 corresponds to slot location 0 on the mainframe and secondary address 15 corresponds to slot location 7 on the mainframe as shown in the following diagram.

Mainframe Slot Locations/Addresses

Slot Location	Mainframe Mode Switch = MAIN							Mainframe Mode Switch = AUX								
	0	1	2	3	4	5	6	7	0	1	2	3	4	5	6	7
Secondary Address	0	1	2	3	4	5	6	7	8	9	10	11	12	13	14	15

Note Secondary addresses are reserved for the mainframe whether modules occupy the associated slot locations or not.

You may want to apply stick-on labels over the slot locations of the mainframe to indicate that the modules installed in the auxiliary mainframe are at secondary addresses 8 to 15. You may also label the modules according to their slot locations. If any modules are removed, they can then be reinstalled in the same slot.

Figure 2-4 illustrates the relationship of the switch settings and secondary addresses. Refer to Chapter 3 for connection information.

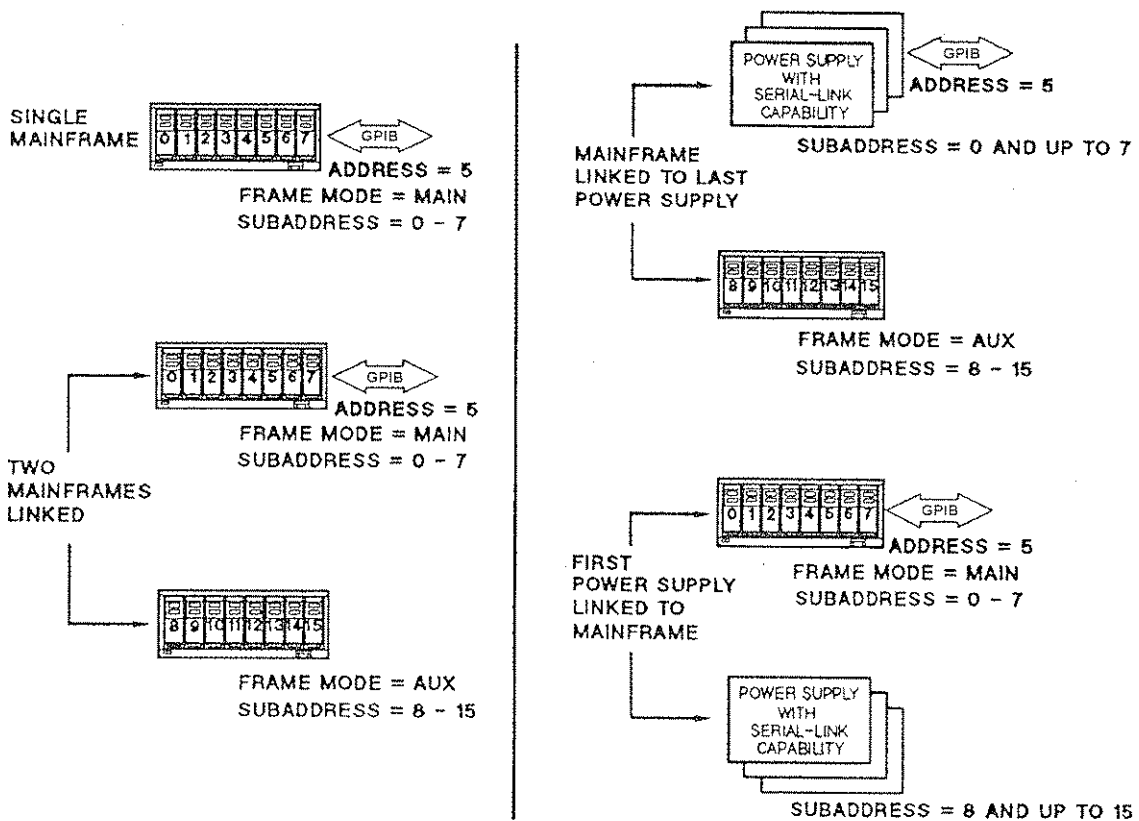

Figure 2-4. Switch Settings

Module Installation

Note A fully loaded mainframe can weigh over 36 kg (80 lbs). Install the mainframe into the rack before installing the modules into the mainframe.

All modules install through the front of the mainframe. Installation (and removal) can be accomplished even when the mainframe is rack-mounted. To install the modules in the mainframe, refer to Figure 2-5 and proceed as follows:

- Use a flat-bladed screwdriver and release the pull tab by pressing down.
- Extend the pull tab from the module so that the serial number is visible.
- Slide the module into the slot until it is fully inserted in the mainframe.
- Push the pull tab into the front of the module. The slot number should be visible below the pull tab.

Note If the module is not fully inserted in the mainframe, the pull tab will not retract into the module.

- Install filler panels in the front of any unused mainframe slots.
- Install the module connectors on the back of the mainframe.

Note Instructions for wiring and installing module connectors are included with each module.

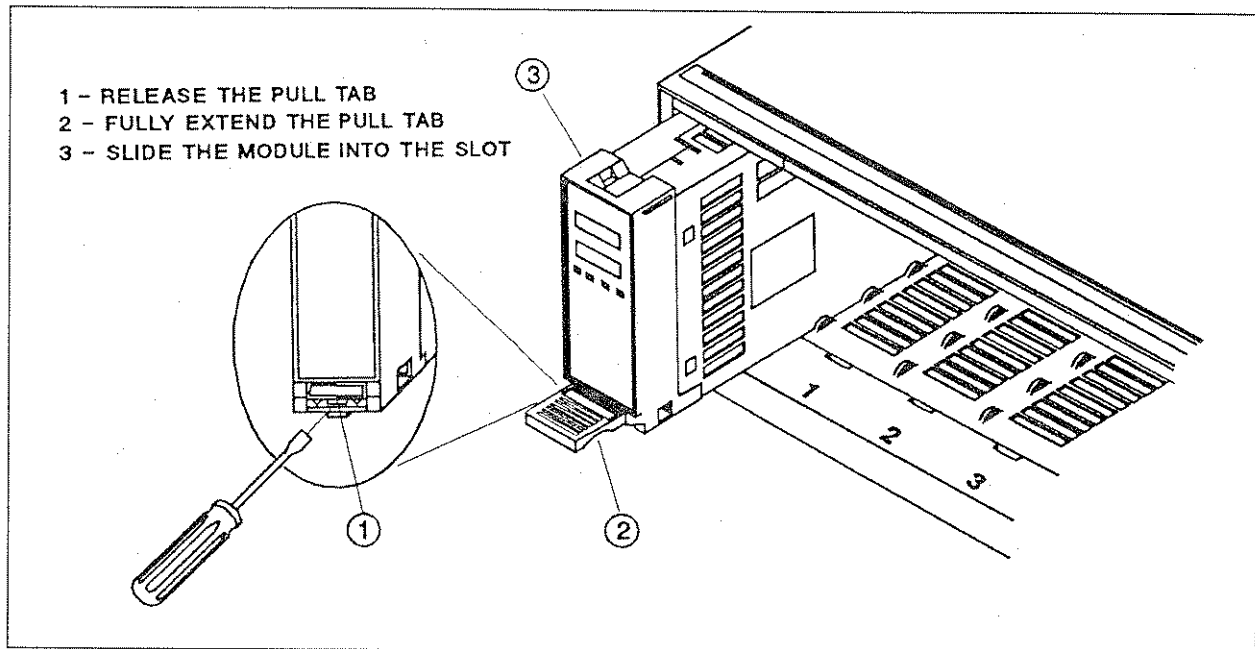

Figure 2-5. Module Pull Tab

Module Removal

All modules are removed through the front of the mainframe. Modules may be removed even when the mainframe is turned on.

CAUTION

- There must be no or minimal current flowing through the connector pins at the back of the module that is being removed. This can be accomplished by disabling the module. If this precaution is repeatedly violated at high current, the connector pins at the back of the module will be damaged.
- There must be no activity on the GPIB bus, the trigger connectors, or the FLT/INH connector of the mainframe when a module is removed. This can be accomplished by not generating any GPIB or FLT/INH activity, and by setting all modules to the trigger idle state (refer to the module *Programming Guide*). If this precaution is violated, GPIB commands to other modules may be corrupted, trigger or FLT/INH data may be lost, or an inadvertent trigger may be generated in another module.

To remove the module from the mainframe, proceed as follows:

- Use a flat-bladed screwdriver and release the pull tab by pressing down (see Figure 2-5).
- Grasp the pull tab and pull the module out of the mainframe.

Note

The module connector remains attached to the mainframe after the module has been removed.

Mainframe Turn-On Checkout

The turn-on checkout procedures that verify module operation also verify the operation of the MPS mainframe. You cannot verify the operation of the mainframe without having at least one installed module. The module self-test sequence checks the following mainframe functions:

- mainframe microprocessor
- GPIB interface
- module/mainframe communications link

Refer to the module *User's Guide* for complete information on the turn-on checkout procedure.

Connections

Rear Panel

Figure 3-1 shows where all of the rear panel connections to the mainframe are made.

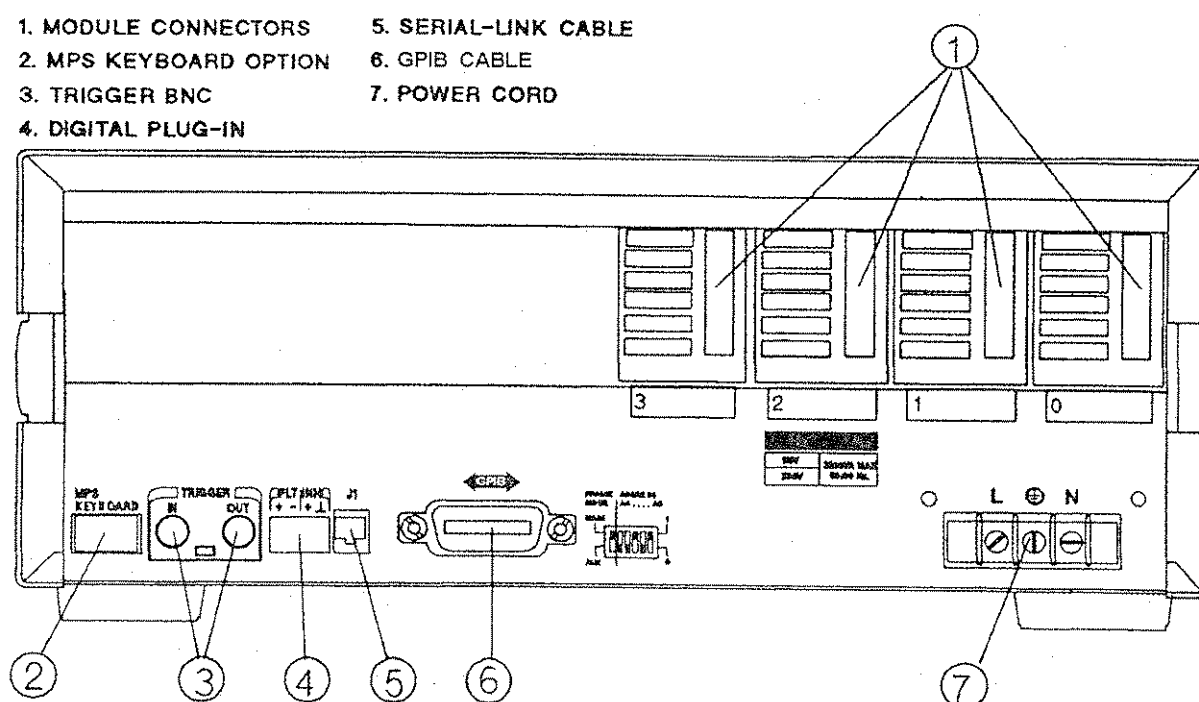

Figure 3-1. Rear Panel Connections

Module Connections

Wire connections to the modules are made using a separate module connector that is supplied with each module. After the module connector has been wired, it simply attaches to the back of the mainframe. You can attach the module connector to the mainframe either before or after the module is installed. Instructions for wiring and attaching the connector are provided with each module.

Note

Install the module connectors from left to right on the back of the mainframe. This makes it easier to access the screws that attach the connectors to the mainframe.

Controller Connections

If you have only one MPS mainframe in your system, simply connect it to the controller using the GPIB cable. If you have more than one mainframe, or if you also have an Agilent 667xA, 665xA, 664xA, or 603xA power supply in your system, you can use the serial-link cable supplied with your mainframe to facilitate connections. Figure 3-2 illustrates the serial-link connections.

Multiple MPS Mainframes

See Figure 3-2. Up to 16 modules may be controlled from a primary GPIB bus address by linking two mainframes.

- The first mainframe in a linked configuration is directly connected to the controller via a GPIB cable. The frame mode switch on the back of this mainframe is set to "MAIN". The first mainframe has a unique primary GPIB address and the modules in this mainframe use secondary addresses (also referred to as subaddresses) 0 through 7.
- The second or "linked" mainframe, connects to the first mainframe with the serial-link cable. The frame mode switch on the back of this mainframe is set to "AUX". The second mainframe uses the same primary address as the first mainframe, but the modules in the second mainframe use secondary addresses 8 through 15.

MPS Mainframe/Power Supply Connections

See Figure 3-2b. Only one mainframe can be serially linked to a system that includes Agilent 667xA, 665xA, 664xA, or 603xA power supplies. Because the mainframe has only one serial-link jack, it can be either linked at the beginning or at the end of a power supply serial link system.

- At the beginning of the serial link system, the mainframe is directly connected to the controller via the GPIB cable. The frame mode switch on the back of this mainframe is set to "MAIN". The mainframe has a unique primary GPIB address and the modules in this mainframe use secondary addresses (also referred to as subaddresses) 0 through 7. All power supplies serially linked to the mainframe use the same primary GPIB address, but must use secondary addresses 8 through 15.
- At the end of the serial link system, the mainframe is linked to the last power supply in the system with the serial-link cable. The frame mode switch on the back of this mainframe is set to "AUX". The mainframe uses the same primary GPIB address as the power supplies and the modules in this mainframe use secondary addresses 8 through 15. In this configuration, you can have up to eight power supplies at secondary addresses 0 through 7 ahead of the mainframe.

Keyboard Connection

The optional Agilent 66001A MPS Keyboard connects to the mainframe through the keyboard jack located at the front of the mainframe and at the back of the mainframe as shown in Figure 3-1. More information on using the keyboard can be found in the module *User's Guide*.

Digital Connections

A 4-pin connector and a quick-disconnect mating plug provide a discrete fault indicator (FLT) output and a remote inhibit (INH) input (see Figure 3-3). Disconnect the mating plug to make your wire connections. The electrical characteristics of the FLT output and the INH input are described in Chapter 1. More information on using digital connectors can be found in Chapter 4 of the module *User's Guide* under "RI Function" and "DFI Function".